

Technische Daten



SPB209CP



7,6kW/10,4Hp

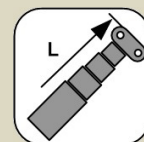

1,9 – 6 m





990kg

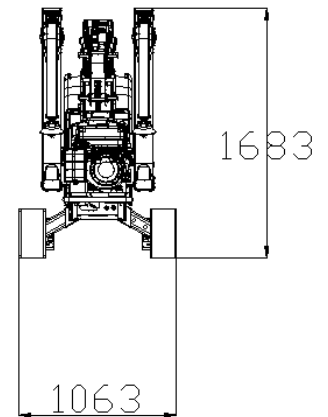
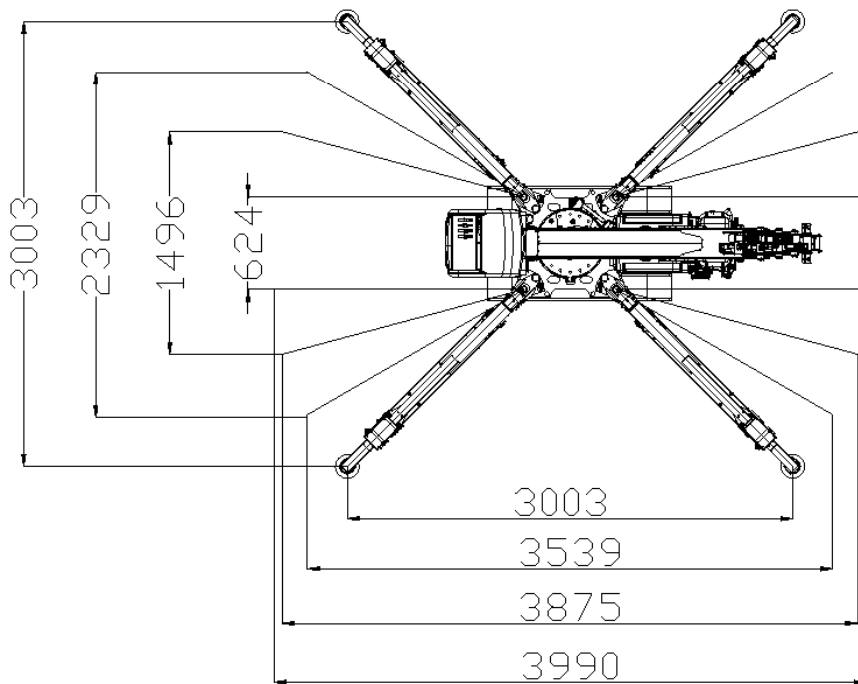
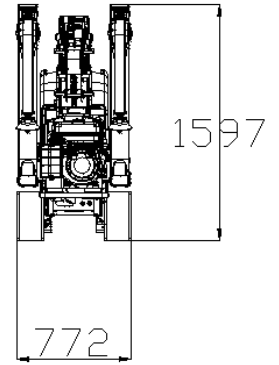
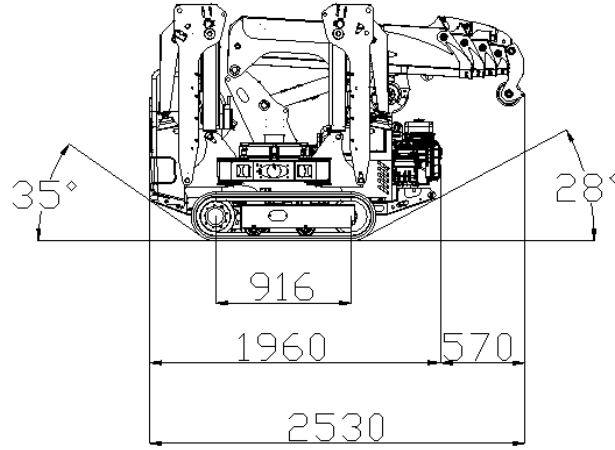

[m] [kg]



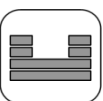

SPB209CP - Abmessungen

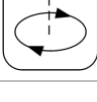

		kg
		1450
		0
Tot.		1450

	km/h	1,7
	20°	
	kg/cm ²	0,40
	kg	1050

	0°/75°	24s
	280°	1,0 rpm
	m	1,9-6,1
		40s

	YAMAHA MZ 360		7,6kW 10,4Hp	
			Benzin	
			l	6

SPB209CP + JIB800GB

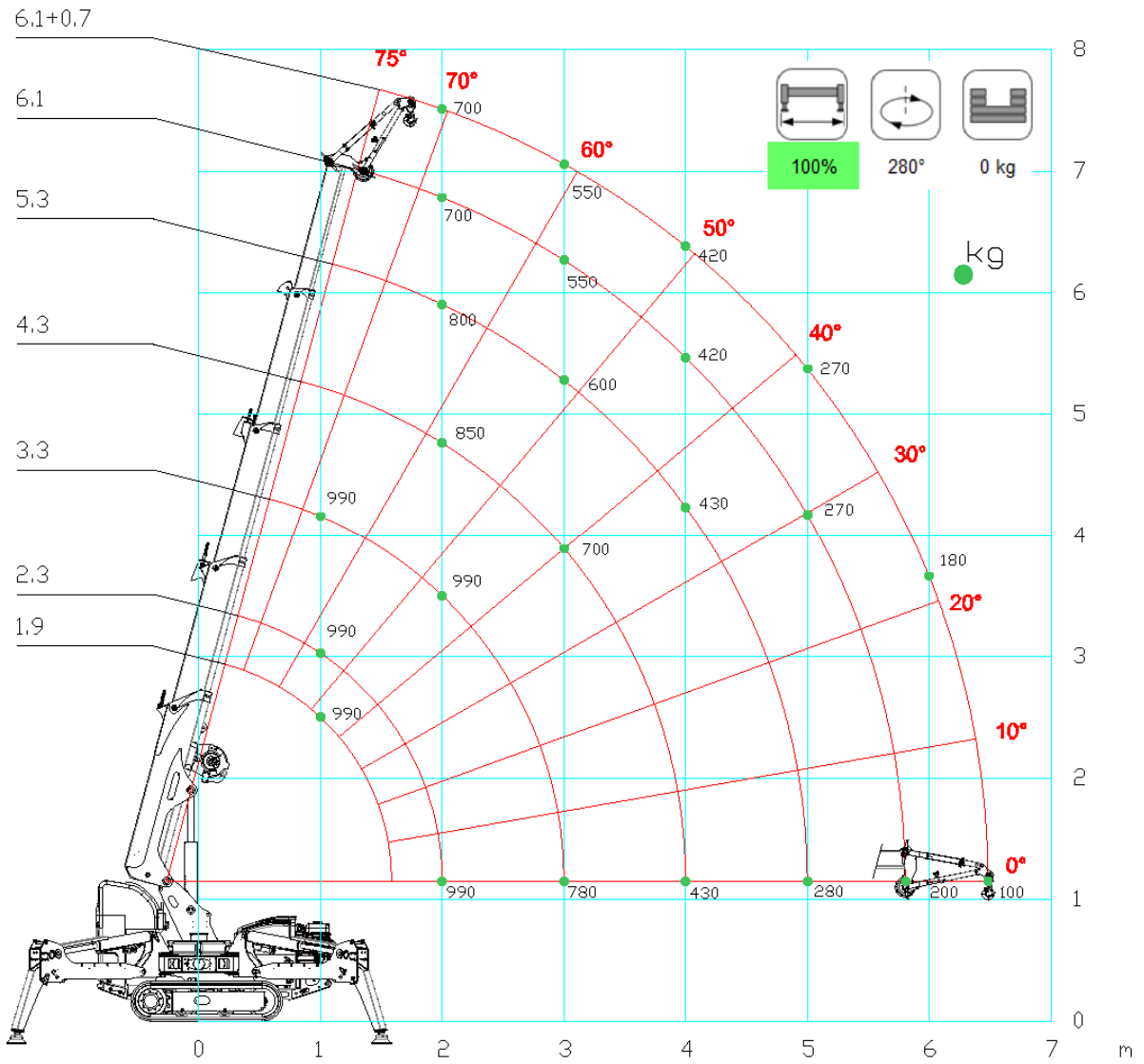

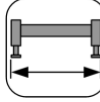
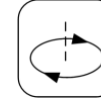
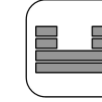
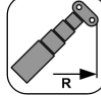

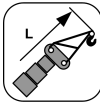
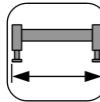
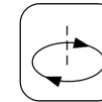
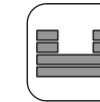
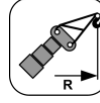
[m] [kg]						
		100%	280°	0 kg		
	1,9	2,3	3,3	4,3	5,3	6,1
1,0	990	990	990			
2,0	990	990	990	850	800	700
3,0			780	700	600	550
4,0				430	430	420
5,0					280	270
5,8						200

[m] [kg]							
	JIB800GB	100%	280°	0 kg			
	2,6	2,3	3,3	4,3	5,3	6,1	6,8
1,0	800	800	800				
2,0		800	800	800	800	700	700
3,0			780	700	600	550	550
4,0				430	430	420	420
5,0					280	270	270
6,0						200	180
6,5							100

Zubehör

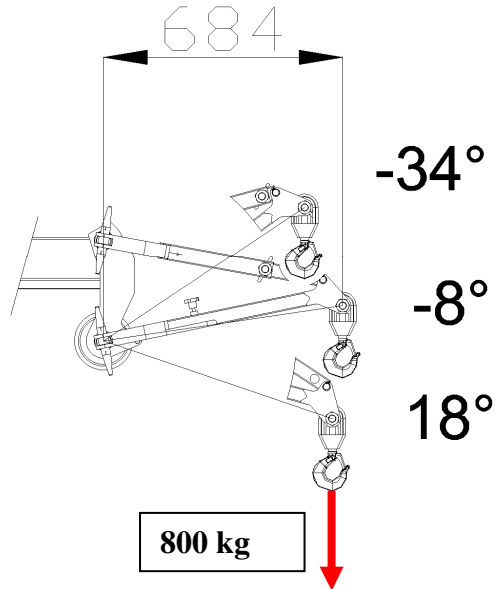
JIB800GB



	kg
	25